

# **High Flow 7000 SXT Series Water Softeners**

## **Operating and Maintenance Manual**



WaterGroup

# Performance and Specifications

Model Number	Capacity - Grains			Flow Rates			Mineral Tank Size inches	Resin Volume cu.ft.	Brine Tank Size W x H inches	Salt Capacity lbs	Shipping Weight lbs
	@ 15lb/cu.ft.	Factory set at 10lb/cu.ft.	@ 6lb/cu.ft.	Service usgpm (lpm)	Peak usgpm (lpm)	Backwash usgpm (lpm)					
HF30EM	30,000	27,500	20,000	10 (38)	12 (45)	2.0 (7.6)	10 x 35	1.0	18 x 35	224	85
HF45EM	45,000	41,250	30,000	12 (45)	16 (61)	2.4 (9.1)	10 x 54	1.5	22 x 38	365	125
HF60EM	60,000	55,000	40,000	13 (49)	19 (72)	3.5 (13)	12 x 52	2.0	22 x 38	365	150
HF90EM	90,000	82,500	60,000	15 (57)	20 (76)	5.0 (19)	14 x 65	3.0	22 x 38	365	235

**Additional Notes:**

Maximum Water Temperature = 110°F (43°C)  
 Maximum Operating Pressure = 100 PSIG (689 kPa)  
 Electrical: 24 VAC/60Hz (120V to 24V CSA Approved transformer included)

- The pressure drop for the stated peak flow rates will not exceed 15 psig through these devices.
- Changing salt settings from factory setting may require changing injector sizes to achieve stated capacities.
- Do not use where water is microbiologically unsafe.
- The manufacturer reserves the right to make product improvements which may deviate from the specifications and descriptions stated herein, without obligation to change previously manufactured products or to note the change.

## How Your High Flow 7000 SXT Series Water Softener Works

Hard water enters your home through the main supply line, enters the softener and passes down through a resin mineral bed which softens the water. An ion exchange process takes place in which the resin beads capture and hold calcium and magnesium, the hardness minerals, while the water takes on sodium ions. The soft water then flows into your household water line.

In normal operation, the Time of Day display will alternate being viewed with the Volume Remaining display. This display will be in gallons, liters or cubic meters. As treated water is used, the Volume Remaining display will count down from a maximum value to zero or (---). Once this occurs, a regeneration cycle will be initiated at the Set Regeneration Time. Water flow through the valve is indicated by the Flow Indicator that will flash in direct relationship to flow rate.

**Example**

833 Gallons of Treated Water Remaining

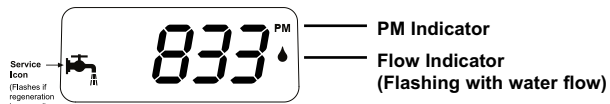

0 Gallons of Treated Water Remaining

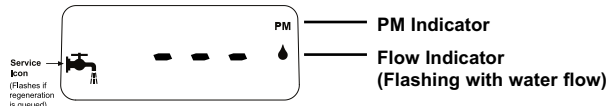

## Control Operation During Regeneration

In regeneration, the control will display a special regeneration display. In this display, the control will show the current regeneration step number the valve is advancing to or has reached and the time remaining in that step. The step number displayed will flash until the valve has completed driving into this regeneration step position. Once all regeneration steps have been completed, the valve will return to Service and resume normal operation.

**Example**

Less than 6 minutes remaining in Regen Step Rapid Rinse

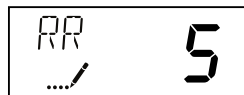

Pushing the Extra Cycle Button during a regeneration cycle will immediately advance the valve to the next cycle step position and resume normal step timing.

## **Control Operation During Programming**

The control will only enter the Program Mode with the valve in Service. While in the Program Mode, the control will continue to operate normally, monitoring water usage and keeping all displays up to date. Control programming is stored in memory permanently, eliminating the need for battery back-up power.

## **Meter Immediate Control**

A meter immediate control measures water usage and regenerates the system as soon as the calculated system capacity is depleted. The control calculates the system capacity by dividing the unit capacity (typically expressed in grains/unit volume) by the feedwater hardness and subtracting the reserve. Meter Immediate systems generally do not use a reserve volume. However, in twin tank systems with soft-water regeneration, the reserve capacity should be set to the volume of water used during regeneration to prevent hard water break-through. A Meter Immediate control will also start a regeneration cycle at the programmed regeneration time if a number of days equal to the regeneration day override pass before water usage depletes the calculated system capacity.

## **Meter Delayed Control**

A Meter Delayed Control measures water usage and regenerates the system at the programmed regeneration time after the calculated system capacity is depleted. As with Meter Immediate systems, the control calculates the system capacity by dividing the unit capacity by the feedwater hardness and subtracting the reserve. The reserve should be set to insure that the system delivers treated water between the time the system capacity is depleted and the actual regeneration time. A Meter Delayed control will also start a regeneration cycle at the programmed regeneration time if a number of days equal to the regeneration day override pass before water usage depletes the calculated system capacity.

## **Time Clock Delayed Control**

A Time Clock Delayed Control regenerates the system on a timed interval. The control will initiate a regeneration cycle at the programmed regeneration time when the number of days since the last regeneration equals the regeneration day override value.

## **Day of the Week Control**

This control regenerates the system on a weekly schedule. The schedule is defined in Master Programming by setting each day to either "off" or "on." The control will initiate a regeneration cycle on days that have been set to "on" at the specified regeneration time.

## **Control Operation During a Power Failure**

The SXT includes integral power backup. In the event of power failure, the control shifts into a power-saving mode. The control stops monitoring water usage, and the display and motor shut down, but it continues to keep track of the time and day for a minimum of 48 hours.

The system configuration settings are stored in a non-volatile memory and are stored indefinitely with or without line power. The Time of Day flashes when there has been a power failure. Press any button to stop the Time of Day from flashing.

If power fails while the unit is in regeneration, the control will save the current valve position before it shuts down. When power is restored, the control will resume the regeneration cycle from the point where power failed. Note that if power fails during a regeneration cycle, the valve will remain in its current position until power is restored. The valve system should include all required safety components to prevent overflows resulting from a power failure during regeneration.

The control will not start a new regeneration cycle without line power. If the valve misses a scheduled regeneration due to a power failure, it will queue a regeneration. Once power is restored, the control will initiate a regeneration cycle the next time that the Time of Day equals the programmed regeneration time. Typically, this means that the valve will regenerate one day after it was originally scheduled. If the treated water output is important and power interruptions are expected, the system should be setup with a sufficient reserve capacity to compensate for regeneration delays.

# Installation Instructions

**All government codes and regulations governing the installation of these devices must be observed.**

**CAUTION:** If the ground from the electrical panel or breaker box to the water meter or underground copper pipe is tied to the copper water lines and these lines are cut during installation of the Noryl bypass valve and/or poly pipe, an approved grounding strap must be used between the two lines that have been cut in order to maintain continuity. The length of the grounding strap will depend upon the number of units being installed and/or the amount of copper pipe being replaced with poly. See Figure 1.

In all cases where metal pipe was originally used and is later interrupted by poly pipe or the Noryl bypass valve as in Figure 1 or by physical separation as in Figure 2, an approved ground clamp with no less than #6 copper conductor must be used for continuity, to maintain proper metallic pipe bonding.

Check your local electrical code for the correct clamp and cable size.

1. Determine the best location for your water softener, bearing in mind the location of your water supply lines, drain line and 120 volt AC electrical outlet. Subjecting the softener to freezing or temperatures above 110°F (43°C) will void the warranty.

## Media Installation (When Necessary)

- Remove the valve from the mineral tank.
  - Temporarily plug the open end of the riser tube to ensure that no resin or gravel falls down into the distribution.
  - Fill mineral tank one quarter full of water to protect distribution during gravel installation.
  - Slowly and carefully add the gravel support bed and the softener media leveling each layer as it is placed into the tank.
  - Unplug the riser tube, carefully position the valve over it and turn the valve into the threads in the fiberglass tank, tightening securely into tank. Note: Ensure that the internal O-ring in the valve fits securely over the riser tube. Silicone grease (#13691) or other food grade lubricant may be applied to the O-ring to ease installation of the riser tube. **DO NOT** use petroleum based lubricants as they will cause swelling of O-rings and seals.
  - The softener is now charged with softening resin.
  - It is recommended that the softener tank now be completely filled with water (SLOWLY) to soak the resin before startup. This will allow the media to absorb water as well as help displace any trapped air. This will reduce the chance of backwashing resin out during startup.
2. Outside faucets used to water lawns and gardens should not supply softened water. A new water line is often required to be connected to supply hard water to the inlet of the water softener and to the outside faucets. Cut the water line between where it enters the house and before any lines that branch off to feed the hot water heater or other fixtures in the house and as near the desired location of the water softener as possible. Install a tee fitting on the feed end of the cut pipe, and an elbow fitting on the other end. Install piping from the tee to the inlet of the water softener and from the elbow to the outlet of the softener. To sever the water lines which branch off to feed any outside faucets, cut the branch lines approximately two inches from the fitting on the main water line. Install an elbow on the end of the pipe nearest the outside faucet and a cap on the end connected to the existing water line. Install piping from the tee installed on the inlet line to the water softener to the elbow installed on the pipe to the outside faucet. Following this procedure will result in all lines in the house, with the exception of the outside faucets, but including the water heater and therefore the hot water lines, being supplied with soft water.

**Figure 1**

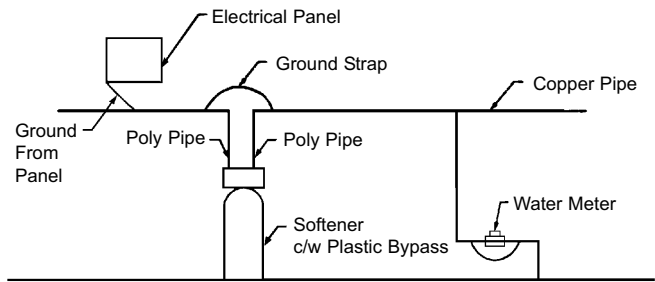

**Figure 2**

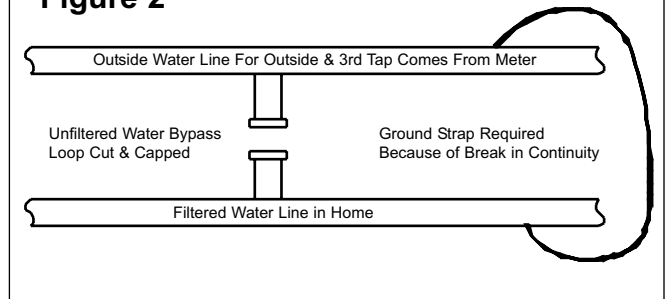

# Installation Instructions

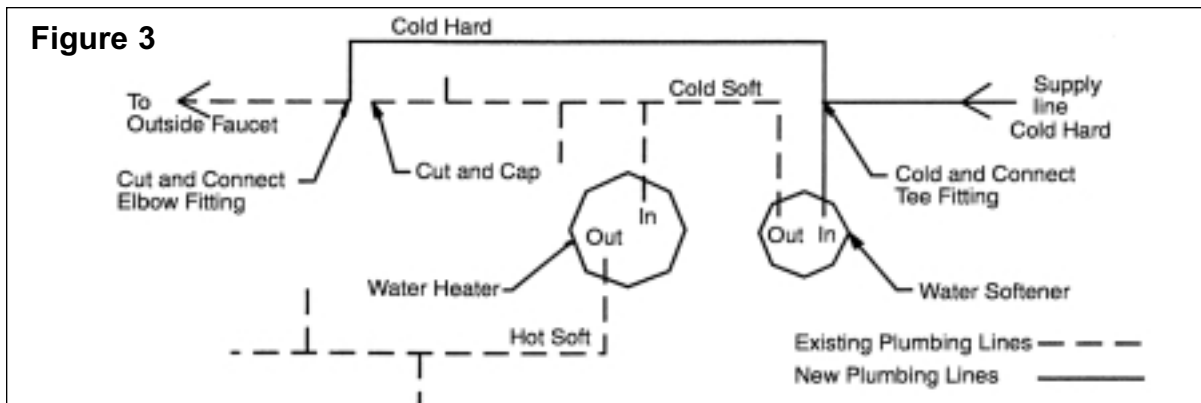

3. Familiarize yourself with the location of the inlet, outlet and drain on the control valve. Be very careful not to get the controls wet.
  4. Attach the bypass valve to the control valve. Connect the inlet and outlet of the water softener to the plumbing in the house. The control valve must not be submitted to temperatures above 71°C (110°F). When sweat fittings are used, to avoid damaging the control valve, solder the threaded copper adapters to the copper pipe and then, using Teflon tape, screw the assembly into the bypass valve.  
**CAUTION** - do not use pipe thread compound as it may attack the material in the valve body.
  5. Run the drain line to a floor drain or a laundry drain. Complete any necessary plumbing.
- NOTE: The 1/2" nylon swivel hose barb fitting used on the 7000 DFCL elbow cannot be used on units larger than 90,000 grain. Contact Customer Service for additional information.**
6. On twin tank units, pull the brine line through the hole in the back of the brine tank. Connect the brine line to the fitting on the side of the valve using the nut and ferrule. Tighten snugly.
  7. Make sure the bypass valve is in the service position.
  8. Plug the 24-volt transformer into a 120 VAC 60 Hz outlet. This valve has five positions: 1) Backwash 2) Brine/Rinse 3) Second Backwash (not used) 4) Rapid Rinse and 5) Brine Refill. When the valve is in the Service position, the *extra cycle* button (far left button as shown on Figure 4) must be pressed and held for 5 seconds before it activates. Press and hold the *extra cycle* button for 5 seconds to advance the valve into the "1" Backwash position. Slowly turn on the water supply and allow the unit to backwash until the air purges out of the tank and clears the system.
  9. Press the *extra cycle* button to advance the valve to the "2" position. Press once more to advance to positions "3" then "4". Press once more to advance to the "5" Brine refill position. Wait until the water level reaches 6" in the brine tank. Water can be added to the tank to speed up the filling but the valve should be in the Brine Refill position for a minimum of two minutes to purge the air out of the injector set.
  10. Press the *extra cycle* button to advance the valve from the Brine Fill position through service to the "2" position Brine/Rinse position. Verify that water is being drawn from the tank. If not, repeat step 9.
  11. Press the *extra cycle* button to advance the valve to the "4" Rapid Rinse position and allow water to run to drain for 2 minutes.
  12. Press the *extra cycle* button to advance the valve to the "5" Brine Fill position until there is 6" of water in the brine tank. Press the *extra cycle* button to advance the valve back into the service position indicated by the red dot in upper left corner of the display.
  13. Put 40 kgs of crystal water softener salt in the brine tank. The unit will automatically fill to the correct level when it regenerates.

**Optional Sanitization Procedure:** We recommend that all new water conditioners be disinfected as part of the startup. Sanitization is achieved by the application of chlorine in the regeneration cycle of the conditioner. A liquid solution of 5.25% sodium hypochlorite (commonly referred to as household bleach) is recommended as a suitable disinfectant. Use only unscented products. For every cubic foot of resin in the softener, pour approximately two (2) tablespoons of sodium hypochlorite into the brine well tube. The brine tank refill in Step 12 should add the correct amount of water to the brine tank. If not, the water can be added manually now. Press and hold the EXTRA CYCLE button to begin a manual regeneration. Press the EXTRA CYCLE button again to advance the valve to the Brine/Rinse position. Allow softener to complete the Brine/Rinse cycle, then let the manual regeneration continue until the brine tank is refilled again with the correct amount of water.

**ALL STATE AND LOCAL GOVERNMENT CODES GOVERNING INSTALLATIONS OF THESE DEVICES MUST BE OBSERVED.**

# Operating Instructions

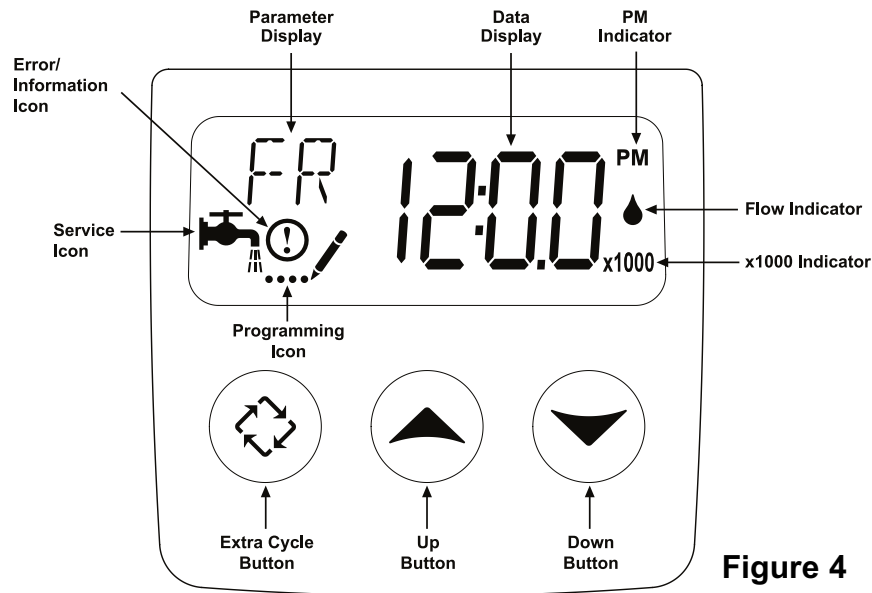

Figure 4

The valve has been pre-programmed with factory settings as follows:

## Regeneration Cycle Step Programming

- |                         |                      |
|-------------------------|----------------------|
| 1. Backwash .....       | 10 minutes           |
| 2. Brine Rinse .....    | 60 minutes           |
| 3. Second Backwash..... | 0 minutes (not used) |
| 4. Rapid Rinse .....    | 10 minutes           |
| 5. Brine Refill .....   | 26 minutes - HF30EM  |
|                         | 20 minutes - HF45EM  |
|                         | 26 minutes - HF60EM  |
|                         | 20 minutes - HF90EM  |

Whenever the valve is in Service the current time of day can be set, the control programmed, or an extra regeneration initiated at any time.

## Set Time of Day

1. Press and hold either the Up or Down buttons until the programming icon replaces the service icon and the parameter display reads TD.
2. Adjust the displayed time with the Up and Down buttons.
3. When the desired time is set, press the Extra Cycle button to resume normal operation. The unit will also return to normal operation after 5 seconds if no buttons are pressed.

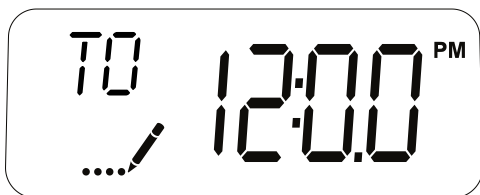

## Queueing a Regeneration

1. Press the Extra Cycle button. The service icon will flash to indicate that a regeneration is queued.
2. To cancel a queued regeneration, press the Extra Cycle button.

## Regenerating Immediately

Press and hold the Extra Cycle button for five seconds.

User Programming Mode Options		
Abbreviation	Parameter	Description
DO	Day Override	The timer's day override setting <b>THIS IS AN OPTION ONLY. PLEASE DO NOT ADJUST BEFORE CONSULTING AN AUTHORIZED DEALER.</b>
RT	Regeneration Time	The time of day that the system will regenerate (meter delayed, timeclock, and day-of-week systems)
H	Feed Water Hardness	The hardness of the inlet water - used to calculate system capacity for metered systems
RC	Reserve Capacity	The fixed reserve capacity
CD	Current Day	The current day of week

**NOTES:**

Some items may not be shown depending on timer configuration.

The timer will discard any changes and exit User Mode if any button is not pressed for sixty seconds.

**User Programming Mode Steps**

1. Press the Up and Down buttons for five seconds while in service, and the time of day is NOT set to 12:01 PM.
2. Use this display to adjust the Day Override. This option setting is identified by "DO" in the upper left hand corner of the screen.



**THIS IS AN OPTION ONLY. PLEASE DO NOT ADJUST BEFORE CONSULTING AN AUTHORIZED DEALER.**

3. Press the Extra Cycle button. Use this display to adjust the Regeneration Time. This option setting is identified by "RT" in the upper left hand corner of the screen.

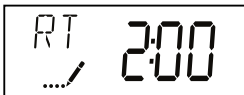

4. Press the Extra Cycle button. Use this display to adjust the Feed Water Hardness. This option setting is identified by "FH" in the upper left hand corner of the screen.

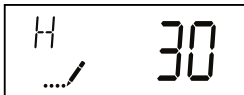

5. Press the Extra Cycle button. Use this display to adjust the Fixed Reserve Capacity. This option setting is identified by "RC" in the upper left-hand corner of the screen.

**75 gallons X # of people in the house = RC**

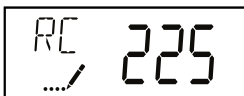

# of People	RC
1	75
2	150
3	225

6. Press the Extra Cycle button to end User Programming Mode.

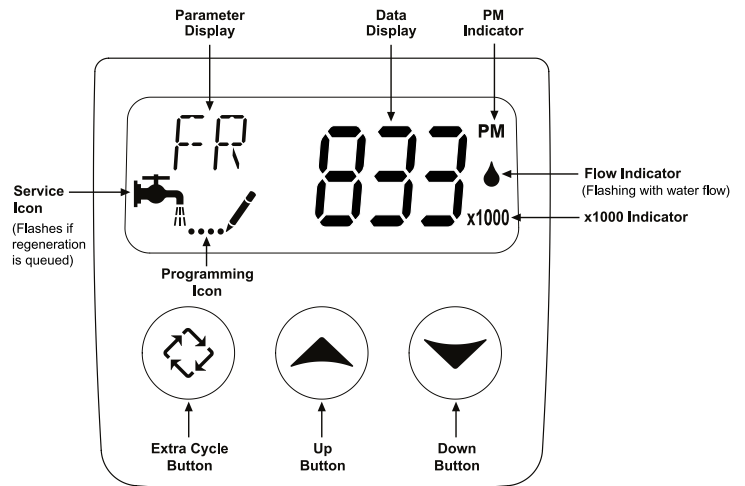

## Error Codes

Note: Error codes appear on the *In Service* display

Error Code	Probable Cause	Recover and Resetting
[Err 0]	Drive motor is stalled	Unplug the unit from the power source
[Err 1]	Drive motor is running continuously	When power is restored to the unit, the Err _ display code clears. If the condition causing the error has not been resolved the Err _ code reappears in the four digit display. Do not attempt to troubleshoot this problem any further.
[Err 2]	<p>There have been more than 99 days since the last Regeneration. If the Day of the Week mode of regeneration is selected and days since last regeneration exceeds 7 days.</p> <p>[ 7 - - 5 ]: There have been more than 7 days since the last regeneration. All individual settings (d1, d2, d3, d4, d5, d6, d7) are set to 0.</p>	<p>Regeneration must occur for the unit to recover, the display to clear and the valve to function normally.</p> <p>[ 7 - - 5 ]: To recover from [Err2], the user must initiate a regeneration or set at least one individual day to 1.</p>
[Err 3]	Control board memory failure.	Perform a Master Reset. If the error returns, do not attempt to troubleshoot this problem any further.

## Error Display Example

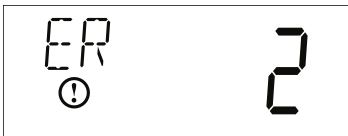

NOTE: Unit will flash when an error exists.

### Manual Regeneration Cycle

If you run out of softened water because of inadequate regeneration frequency, inadequate reserve capacity, power failure or unusually high water usage, you can initiate a manual regeneration simply by pressing the extra cycle button for 5 seconds. The softener will now automatically complete a regeneration cycle and return to service. If possible, avoid water use during the regeneration cycle.

If, once you have set your softener, you experience frequent loss of water pressure, you may have to increase the frequency of regeneration by resetting the gallons between regeneration.

### Automatic Bypass

The regeneration cycle lasts approximately 2-1/2 hours, after which soft water service will be restored. During regeneration, hard water is automatically bypassed for use in the household. Hot water should be used as little as possible during this time to prevent hard water from filling the water heater. This is why the automatic regeneration is set for sometime during the night and manual regenerations should be performed when little or no water will be used in the household.

### Safety Float

The brine tank is equipped with a safety float which prevents your brine tank from over filling as a result of a malfunction such as a power failure.

### Water Pressure

Your softener is designed to operated under normal water pressures from 20 psi to 100 psi.

### New Sounds

You may notice new sounds as your water softener operates. The regeneration cycle lasts approximately 90 minutes. During this time, you may hear water running intermittently to the drain.

### Manual Bypass (Figure 5)

In case of an emergency such as an overflowing brine tank, you can isolate your water softener from the water supply using the bypass valve located at the back of the control.

In normal operation the bypass is open with the ON/OFF knobs in line with the INLET and OUTLET pipes. To isolate the softener, simply rotate the knobs clockwise (as indicated by the word BYPASS and arrow) until they lock.

You can use your water related fixtures and appliances as the water supply is bypassing the softener. However, the water you use will be hard.

To resume soft water service, open the bypass valve by rotating the knobs counter-clockwise.

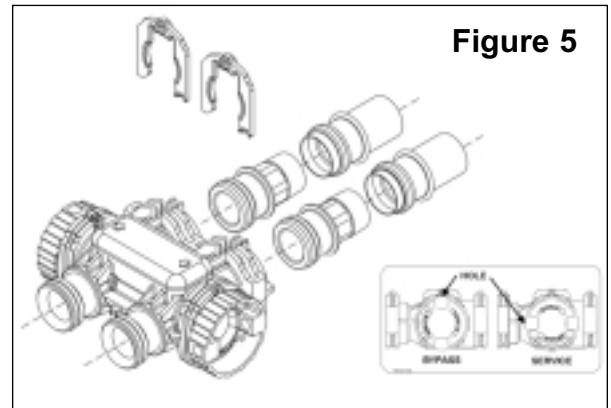

# Maintenance Instructions

## Checking the Salt Level

Check the salt level monthly. Remove the lid from the cabinet or brine tank, make sure salt level is always above the brine level (you should not be able to see water).

## Adding Salt

Use only clean salt labeled for water conditioner use, such as crystal, pellet, nugget, button or solar.

The use of rock salt is discouraged because it contains insoluble silt and sand which build up in the brine tank and can cause problems with the system's operation.

Add the salt directly to the tank, filling no higher than the top of the brine well.

## Caution

Liquid brine will irritate eyes, skin and open wounds - gently wash exposed area with fresh water. Keep children away from your water conditioner.

## Bridging (Figure 6)

Humidity or the wrong type of salt may create a cavity between the water and the salt. This action, known as "bridging", prevents the brine solution from being made, leading to your water supply being hard.

If you suspect salt bridging, carefully pound on the outside of the plastic brine tank or pour some warm water over the salt to break up the bridge. This should always be followed up by allowing the unit to use up any remaining salt and then thoroughly cleaning out the brine tank. Allow four hours to produce a brine solution, then manually regenerate the softener.

## Care of Your Softener

To retain the attractive appearance of your new water softener, clean occasionally with a mild soap solution. Do not use abrasive cleaners, ammonia or solvents. Never subject your softener to freezing or to temperatures above 110°F (43°C).

## Cleaning the Injector Assembly (Figure 7)

Sediment, salt and silt will restrict or clog the injector. A clean water supply and pure salt will prevent this from happening.

The injector assembly is located on the top of the control valve. This assembly is easy to clean.

Shut off the water supply to your softener and reduce the pressure by opening a cold soft water faucet. Remove the injector cap clip. Next remove the injector cap. Carefully remove the assembly and disassemble as shown in Figure 7. The injector assembly is removed from the valve body by carefully using the injector cap clip. Note: Do not rotate the injector when removing. Carefully flush all parts. Use a mild acid such as vinegar or Pro-Rust Out to clean the small holes in the orifice and throat.

Reassemble using the reverse procedure.

## Resin Cleaner

An approved resin cleaner MUST be used on a regular basis if your water supply contains iron. The amount of resin cleaner and frequency of use is determined by the quantity of iron in your water (consult your local representative or follow the directions on the resin cleaner package).

**Figure 6**

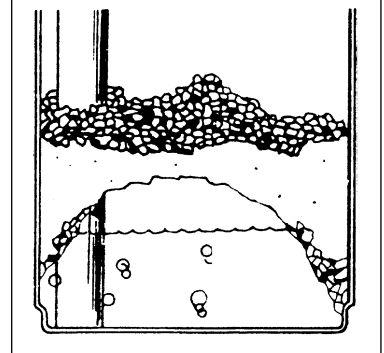

**Figure 7**

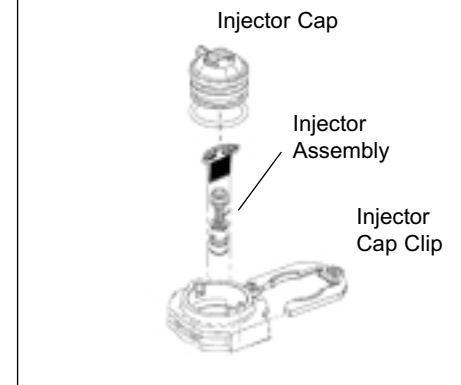

# Trouble Shooting Guide

<p><b>1. CONDITIONER DELIVERS HARD WATER</b>          Bypass valve is open          No salt in brine tank          Injector or screen plugged          Insufficient water flowing into brine tank          Hot water tank hardness          Leak at distributor tube          Internal valve leak          Flow meter jammed          Flow meter cable disconnected or not plugged into meter cap          Improper programming</p>	<p>Close bypass valve          Add salt to brine tank and maintain salt level above water level          Replace injectors and screen          Check brine tank fill time and clean brine line flow tank control if plugged          Repeated flushing of the hot water tank is required          Make sure distributor tube is not cracked. Check O ring and tube pilot          Replace seals and spacers and/or piston          Remove obstruction from flow meter          Check meter cable connection to timer and meter cap</p> <p>Reprogram the control to the proper regeneration type, inlet water hardness, capacity or flow meter size.</p>
<p><b>2. CONDITIONER FAILS TO REGENERATE</b>          Electrical service to unit has been interrupted          Timer is not operating properly          Defective valve drive motor          Improper programming</p>	<p>Assure permanent electrical service (check fuse, plug, chain or switch)          Replace timer          Replace drive motor          Check programming and reset as needed</p>
<p><b>3. UNIT USES TOO MUCH SALT</b>          Improper salt setting          Excessive water in brine tank          Improper programming</p>	<p>Check salt usage and salt setting          See #7          Check programming and reset as needed</p>
<p><b>4. LOSS OF WATER PRESSURE</b>          Iron build-up in line to water conditioner          Iron build-up in water conditioner</p> <p>Inlet of control plugged due to foreign material broken loose from pipes by recent work done on plumbing system</p>	<p>Clean line to water conditioner          Clean control and add resin cleaner to resin bed. Increase frequency of regeneration          Remove piston and clean control</p>
<p><b>5. LOSS OF RESIN THROUGH DRAIN LINE</b>          Air in water system</p> <p>Drain line flow control is too large</p>	<p>Assure that well system has proper air eliminator control. Check for dry well condition.          Ensure drain line flow control is sized</p>
<p><b>6. IRON IN CONDITIONED WATER</b>          Fouled resin bed</p> <p>Iron content exceeds recommended parameters</p>	<p>Check backwash, brine draw and brine tank fill. Increase frequency of regeneration. Increase backwash time.          Add iron removal filter system</p>
<p><b>7. EXCESSIVE WATER IN BRINE TANK</b>          Plugged drain line flow control          Brine valve failure          Improper programming</p>	<p>Clean flow control          Replace brine valve          Check programming and reset as needed</p>
<p><b>8. SALT WATER IN SERVICE LINE</b>          Plugged injector system          Timer not operating properly          Foreign material in brine valve          Foreign material in brine line flow control          Low water pressure          Improper programming</p>	<p>Clean injector and replace screen          Replace timer          Clean or replace brine valve          Clean brine line flow control          Raise water pressure          Check programming and reset as needed</p>
<p><b>9. CONDITIONER FAILS TO DRAW BRINE</b>          Drain line flow control is plugged          Injector is plugged          Injector screen is plugged          Line pressure is too low          Internal control leak          Improper programming          Timer not operating properly</p>	<p>Clean drain line flow control          Clean or replace injectors          Replace screen          Increase line pressure (line pressure must be at least 20 psi at all times)          Change seals and spacers and/or piston assembly          Check programming and reset as needed          Replace timer</p>
<p><b>10. CONTROL CYCLES CONTINUOUSLY</b>          Timer not operating properly          Faulty microswitches and/or harness          Faulty cycle cam operation</p>	<p>Replace timer          Replace faulty microswitch or harness          Replace cycle cam or reinstall</p>
<p><b>11. DRAIN FLOWS CONTINUOUSLY</b>          Foreign material in control</p> <p>Internal control leak          Control valve jammed in brine or backwash position          Timer motor stopped or jammed teeth          Timer not operating properly</p>	<p>Remove piston assembly and inspect bore. Remove foreign material and check control in various regeneration positions          Replace seals and/or piston assembly          Replace piston and seals and spacers          Replace timer motor and check all gears for missing teeth          Replace timer</p>

# Guarantee

**WaterGroup** guarantees that your new water conditioner is built of quality material and workmanship. When properly installed and maintained, it will give years of trouble free service.

**Seven Year Complete Parts Guarantee:**

**WaterGroup** will replace any part which fails within 84 months from date of manufacture, as indicated by the serial number provided the failure is due to a defect in material or workmanship. The only exception shall be when proof of purchase or installation is provided and then the warranty period shall be from the date thereof.

**Lifetime Guarantee on Mineral Tanks and Brine Tanks:**

**WaterGroup** will provide a replacement mineral tank or brine tank to any original equipment purchaser in possession of a tank that fails within his/her lifetime, provided that the water conditioner is at all times operated in accordance with specifications and not subject to freezing.

**General Provisions:**

**WaterGroup** assumes no responsibility for consequential damage, labor or expense incurred as a result of a defect or for failure to meet the terms of these guarantees because of circumstances beyond its control.

## WaterGroup